

Wind Alarm Unit, Universal

Instruction for Use

4.3244.0x.000

From Softwareversion V2.6



Dok. No. 021757/10/22

THE WORLD OF WEATHER DATA

Safety Instructions

- Before operating with or at the device/product, read through the operating instructions. This manual contains instructions which should be followed on mounting, start-up, and operation. A non-observance might cause:
 - failure of important functions
 - endangerment of persons by electrical or mechanical effect
 - damage to objects
- Mounting, electrical connection and wiring of the device/product must be carried out only by a qualified technician who is familiar with and observes the engineering regulations, provisions and standards applicable in each case.
- Repairs and maintenance may only be carried out by trained staff or **Adolf Thies GmbH & Co. KG**. Only components and spare parts supplied and/or recommended by **Adolf Thies GmbH & Co. KG** should be used for repairs.
- Electrical devices/products must be mounted and wired only in a voltage-free state.
- **Adolf Thies GmbH & Co KG** guarantees proper functioning of the device/products provided that no modifications have been made to the mechanics, electronics or software, and that the following points are observed:
 - All information, warnings and instructions for use included in these operating instructions must be taken into account and observed as this is essential to ensure trouble-free operation and a safe condition of the measuring system / device / product.
 - The device / product is designed for a specific application as described in these operating instructions.
 - The device / product should be operated with the accessories and consumables supplied and/or recommended by **Adolf Thies GmbH & Co KG** .
 - Recommendation: As it is possible that each measuring system / device / product may, under certain conditions, and in rare cases, may also output erroneous measuring values, it is recommended using redundant systems with plausibility checks for **security-relevant applications**.

Environment

- As a longstanding manufacturer of sensors Adolf Thies GmbH & Co KG is committed to the objectives of environmental protection and is therefore willing to take back all supplied products governed by the provisions of "*ElektroG*" (German Electrical and Electronic Equipment Act) and to perform environmentally compatible disposal and recycling. We are prepared to take back all Thies products concerned free of charge if returned to Thies by our customers carriage-paid.
- Make sure you retain packaging for storage or transport of products. Should packaging however no longer be required, please arrange for recycling as the packaging materials are designed to be recycled.



Documentation

- © Copyright **Adolf Thies GmbH & Co KG**, Göttingen / Germany
- Although these operating instructions have been drawn up with due care, **Adolf Thies GmbH & Co KG** can accept no liability whatsoever for any technical and typographical errors or omissions in this document that might remain.
- We can accept no liability whatsoever for any losses arising from the information contained in this document.
- Subject to modification in terms of content.
- The device / product should not be passed on without the/these operating instructions.

Contents

1	Models	5
2	Application	6
2.1	Mode of wind alarm unit.....	6
3	Construction.....	8
3.1	Functional sequence	8
4	Mode of operation	10
4.1	Signal inputs for wind transmitter.....	10
4.2	Wind alarm channel and relay output.....	10
4.3	Wind sector channel	11
4.4	Wind alarm level and hysteresis	11
4.5	Static and dynamic switch-on and switch-off delay	12
4.6	Wind sector	13
4.7	Functions of status LEDs.....	13
4.8	Relay functions.....	14
4.8.1	Definition:.....	14
4.9	Error detection for wind sensor	14
4.9.1	Timeout function	14
4.10	Parameter key	14
4.11	RS485 serial interface	15
5	Connectable wind transmitters	15
5.1	Wind transmitter type group 1: Wind velocity transmitter Digital / Analogue.....	16
5.2	Wind transmitter type group 2: Combined wind transmitter Digital	16
5.3	Wind transmitter type group 3: Wind direction transmitter Digital / Analogue	16
5.4	Wind transmitter type group 4: Wind transmitter with RS485 interface.....	17
5.4.1	List of wind transmitter types.....	18
5.5	Wind transmitter type group 5: connection of unlisted wind velocity transmitters (third-party transmitters)	19
6	Installation.....	20
6.1	Recommendation for selection of site.....	20
6.2	Mechanical mounting.....	21
6.3	Electrical installation	22
7	Operation / Programming using buttons.....	25
7.1	Release of parameter setting (Parameter-Key).....	29
7.1.1	Language Settings	29
7.2	Selecting the Wind Velocity Level.....	30
7.3	Selecting switch-on and switch-off delay	31
7.4	Selecting wind sector.....	31
7.5	Selecting Wind Velocity Hysteresis.....	32
7.6	Selecting static or dynamic on/off delays	32
7.7	Selecting baud rate.....	33
7.8	Selecting WV timeout (Error)	33
7.9	Selecting wind alarm type.....	34
7.10	Selecting wind transmitter type group	34
7.11	Selecting wind transmitter type	35
7.12	Selecting wind direction transmitter type.....	36

7.13	Parameterisation of a third-party wind transmitter.....	37
7.14	Programming examples.....	38
8	Operation / Programming via COM interface.....	39
8.1	Format.....	39
8.2	List of commands	40
8.3	Commands	41
9	Error messages	49
10	Maintenance	50
11	Example: Installation / Setting / Start-up	51
12	Technical data	53
13	Dimension drawing	55
14	More Information / Documents as download	56
15	EC-Declaration of Conformity	57
16	UK-CA-Declaration of Conformity	58
	Appendix 1: List of connected wind transmitter.....	59

Figure

Figure 1:	Example of an application with wind alarm type 3.....	7
Figure 2:	Example of an application with wind alarm type 4.....	7
Figure 3:	Explanation	8
Figure 4:	Wind alarm type 1	9
Figure 5:	Wind alarm type 2	9
Figure 6:	Wind alarm type 3	9
Figure 7:	Wind alarm type 4	9
Figure 8:	Wind sector	11
Figure 9:	Electrical connection.....	23
Figure 10:	Connection of digital combi wind transmitter.....	23
Figure 11:	Connection of wind transmitter with reed contact.....	23
Figure 12:	Relay output	24
Figure 13:	RS485 input circuit	24

Table

Table 1:	Models.....	5
Table 2:	LED function.....	13
Table 3:	List of wind transmitter types	19
Table 4:	Display menu.....	26
Table 5:	List of commands	40
Table 6:	Baud rate code	45
Table 7:	Error messages	49

1 Models

Designation	Order No.	Operating voltage
Universal wind alarm unit	4.3244.00.000	230VAC and / or 24VAC or 15...30VDC

Table 1: Models

Features

- Wind alarm unit in a plastic housing for mounting on a carrier rail.
- Selectable power supply.
- Two-line (2x16 characters) liquid-crystal display (LCD).
- 2 LEDs for display of wind alarm status.
- Current wind velocity and wind direction shown on the display.
- Error codes shown on the display.
- Display / adjustment options of selectable parameters on the display using 4 buttons or via the serial interface.
- Permanent storage of selected parameters.
- 2 independent wind alarm channels with selectable switch-on and switch-off delay.
- Wind transmitter monitoring for line interruption and short circuit.
- Wind velocity (WV) and wind direction (WD) - timeout monitoring.
- Protection from accidental change of parameters.
- 2 isolated relay outputs.
- Option for connection of different Thies wind transmitter device models.
- Option for connection and parameterisation of external (digital) WV transmitters.
- RS485 interface for connection of a wind transmitter with COM interface.
- Option for selection of wind alarm type:
 - wind alarm type 1: 1 x wind velocity alarm 1 relay output
 - wind alarm type 2: 2 x wind velocity alarms 2 relay outputs
 - wind alarm type 3: 1 x WV alarm as a function of wind direction 1 relay output
 - wind alarm type 4: 2 x WV alarms as a function of wind direction 2 relay outputs

The following parts are included in delivery:

- 1 Instrument
- 1 Instruction for Use

The instructions for use are available for download under the following link:

https://www.thiesclima.com/db/dnl/4.3244.0x.000_Wind_Alarm_Unit_Universal_eng.pdf

2 Application

The wind alarm unit is designed for applications which protect buildings and other structures as well as technical installations. It can be used as a preventative measure in conjunction with an anemometer or / and wind direction sensor to protect structures at risk from wind such as buildings, cranes, bridges, solar installations, cable railways, masts, greenhouses, blinds and awnings, etc.

Risks can ensue from

- the strength (velocity) of the wind.
- aerosols transported by wind (dust, smoke, soot, fumes, pollen, bacteria).
- odours and noise.

2.1 Mode of wind alarm unit

Different structures require different warning parameters. Careful selection of modes and parameter settings allow the alarm unit to cater for different requirements, e.g. standards for temporary installations, chair lifts, wind energy plants, tower cranes, sunscreens, bridges etc.

Options for selection:

Wind alarm type 1:

1 x wind velocity alarm.

Here the user selects one wind alarm level (limit value) for the wind velocity at which the relevant protective measure is to be initiated.

Wind alarm type 2:

2 x wind velocity alarms.

Here the user selects two wind alarm levels (limit value) for the wind velocity, with one possibly acting for example as an advance warning and the second initiating the actual protective measure.

Wind alarm type 3:

1 x wind velocity alarm depending on the wind direction.

Here the user selects a wind alarm level (limit value) for the wind velocity and a wind sector presenting a possible risk to the structure requiring protection and subsequent gating.

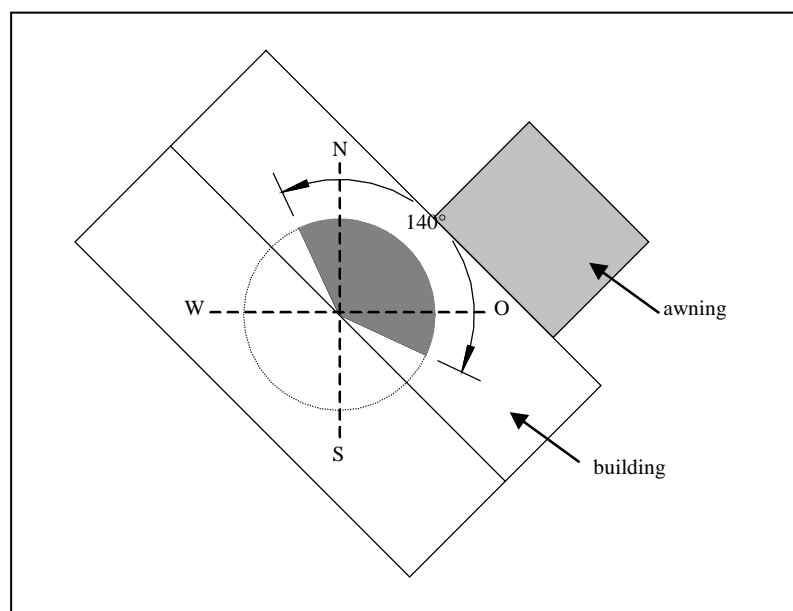


Figure 1: Example of an application with wind alarm type 3

Wind alarm type 4:

As for wind alarm type 3, however with

2 x wind velocity alarms depending on the wind direction for use where the structures requiring protection are not in alignment.

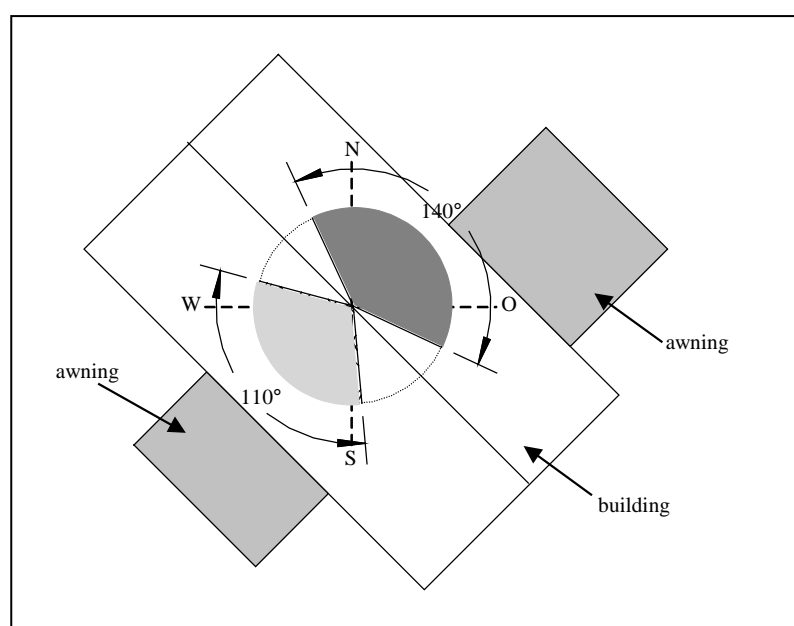


Figure 2: Example of an application with wind alarm type 4

3 Construction

The wind alarm unit combines four different *types* of wind alarm unit in one device and can be configured according to the individual application.

3.1 Functional sequence

The wind alarm unit consists of the following function blocks:



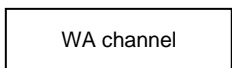




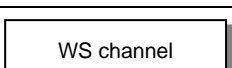



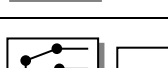
Wind velocity input	
Wind direction transmitter input	
Wind alarm channel	
Input wind alarm level 1	
Input wind alarm level 2	
Input switch-on delay	
Input switch-off delay	
Wind sector channel	
Input wind sector 1	
Input wind sector 2	
Relay output 1	
Relay output 2	

Figure 3: Explanation

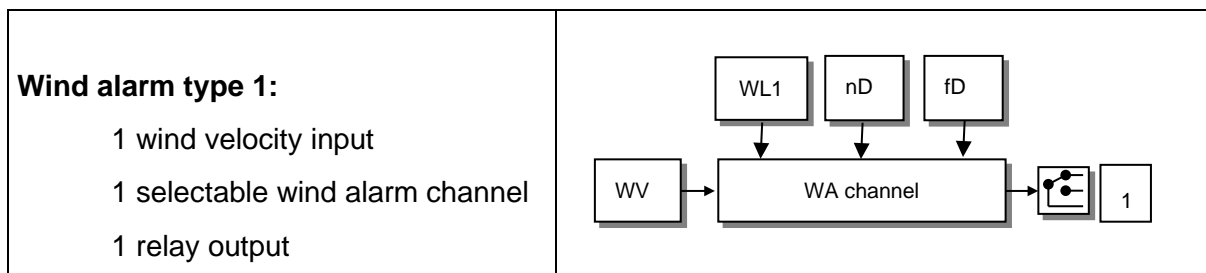


Figure 4: Wind alarm type 1

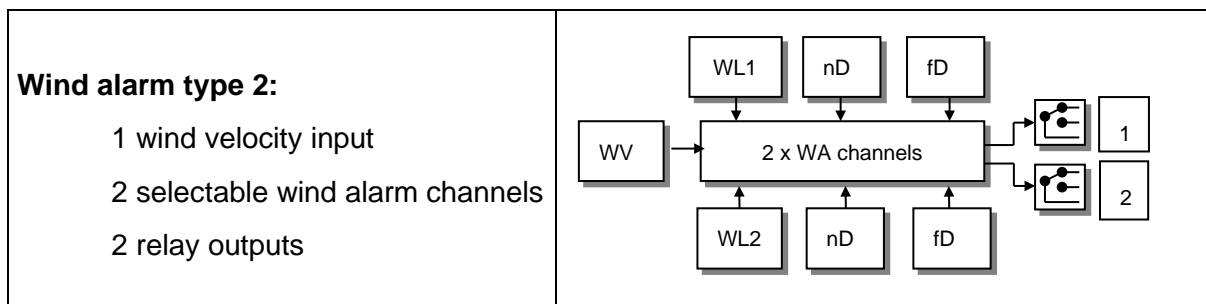


Figure 5: Wind alarm type 2

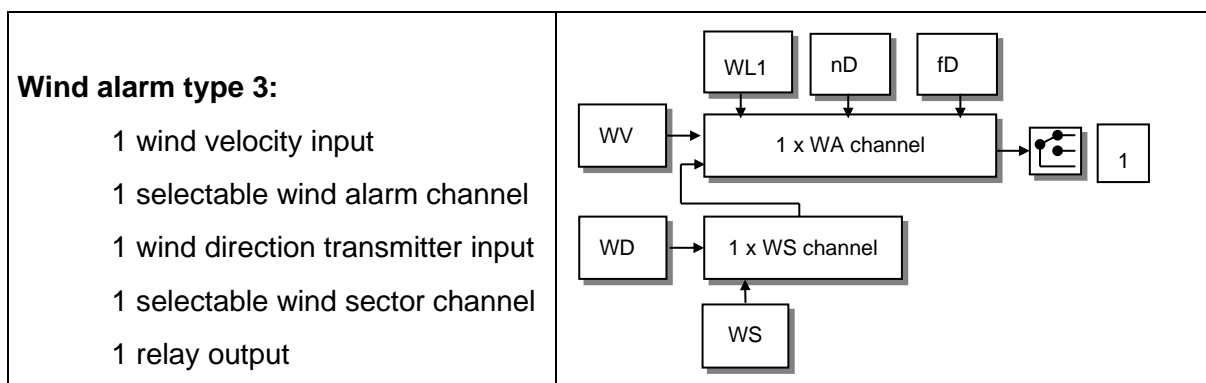


Figure 6: Wind alarm type 3

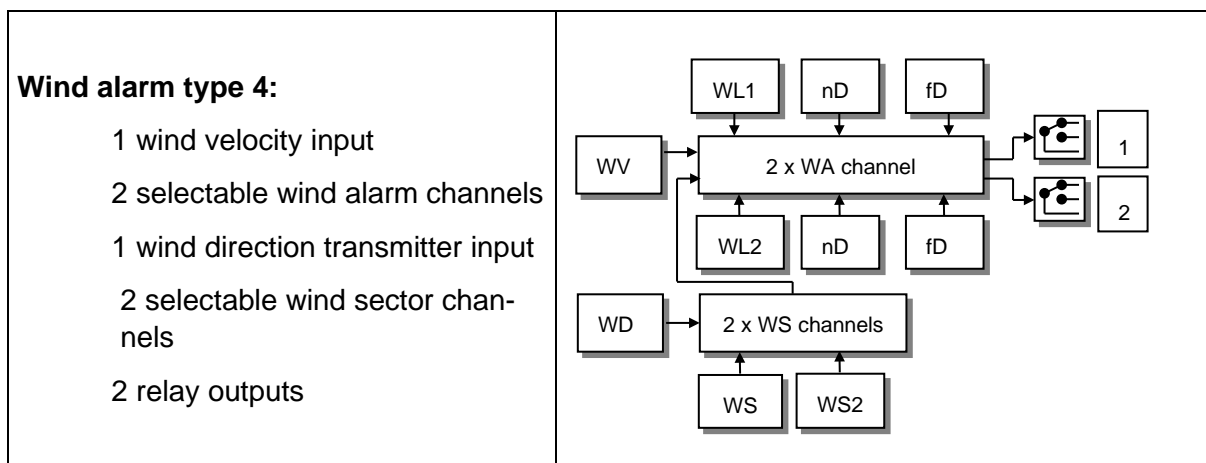


Figure 7: Wind alarm type 4

4 Mode of operation

4.1 Signal inputs for wind transmitter

The wind velocity and wind direction transmitter input allow various different Thies digital and analog wind transmitters to be connected. The wind transmitter input is configured according to the transmitter selected in the device menu, also including application of the appropriate supply voltage for the wind transmitter. Depending on the type of wind transmitter, error detection routines will also be activated in the event of an error. This results in an error message being output to the LCD display and causes the status LED to flash red and switch the relay output to the wind alarm position.

During the error detection routine the power consumption of the wind transmitter is continuously compared with the relevant set point values.

Exceptions here are wind transmitters equipped with a reed contact. To ensure error detection in this case as well under certain conditions (e.g. no WV pulses), it is possible to program the so-called WV-Timeout time (see **section 7.8**) in the device menu.

Alternatively, wind parameters can also be received via the serial interface (RS485). In this case no supply voltage is made available at the wind transmitter input.

4.2 Wind alarm channel and relay output

Selection of the required wind alarm type in the device menu will configure the functional unit of the wind alarm channel accordingly. The wind alarm channel offers functions such as the wind alarm level, switch-on and switch-off delay and a relay output. The device menu can also be used for setting parameters such as the wind alarm level, etc. A maximum of two wind alarm channels can be activated. They function independently of each other and are each equipped with one relay output with a changeover contact.

4.3 Wind sector channel

In the case of wind alarm types with the wind alarm depending on the wind direction (types 3 and 4), logic "AND gating" of the wind sector channel with the wind alarm channel takes place so that only one wind alarm can occur in the preselected wind sector (see below, **Figure 8: Wind sector**).

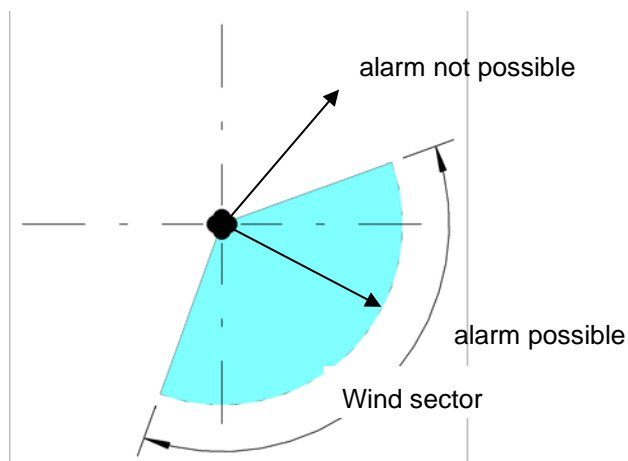
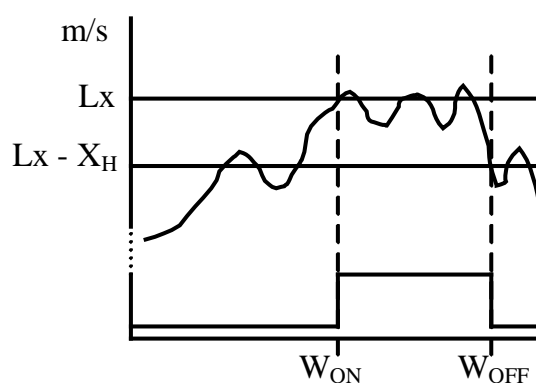


Figure 8: Wind sector

4.4 Wind alarm level and hysteresis

The wind alarm level (L_x) can be set within a range of 1 and 50m/s in increments of 1m/s (see **section 7.2**). If the wind velocity (WV) reaches the wind alarm level (L_x), a wind alarm will be triggered (at the end of the selectable switch-on delay (nD), see **section 7.3**). To avoid fluctuation around the wind alarm level and associated switching, it is reduced by the WV hysteresis value (e.g. 1m/s, X_H) after exceeding of the wind alarm level (L_x , see figure) and the switch-on delay (nD). The WV hysteresis can be adjusted in the device menu in increments of 0.1m/s (see **section 7.5**).

The figure shows the operation, although the selectable switch-on / switch-off delays (see **section 4.5**) are not indicated.



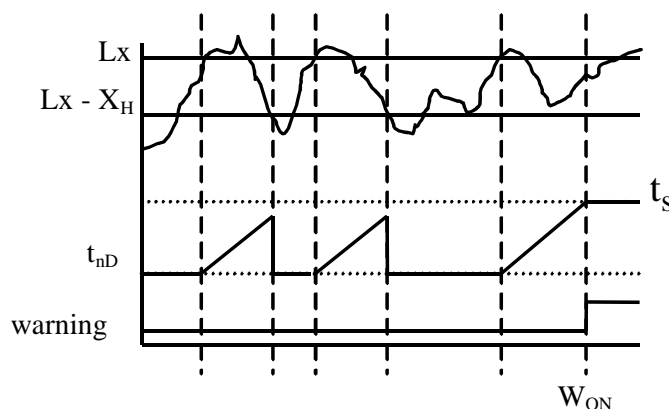
4.5 Static and dynamic switch-on and switch-off delay

While the switch-on delay t_{nD} , ('EV' in the figure) can be set between 0 and 120 in increments of 1 second, the switch-off delay (t_{fD}) can be set between 0 and 240 in increments of 1 minute (selection: see **section 7.3**).

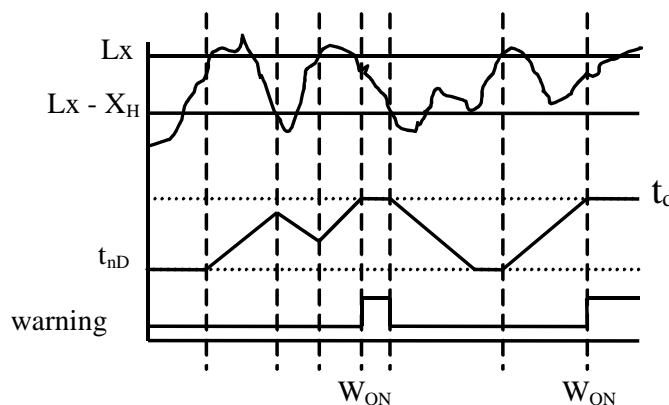
In conjunction with the switch-on and switch-off delay there is the option of selecting either **static** or **dynamic** processing of the delay times (selection: see **section 7.6**).

With **static processing** the switch-on delay timer is reset after failure to reach the wind alarm level before the end of the switch-on delay time. The same also takes place in reverse with the switch-off delay (see figure above)

With **dynamic processing** the switch-on delay timer is reversed in its count direction and not reset after failure to reach the wind alarm level before the end of the switch-on delay time (see figure below). This increases the likelihood of switch-on with wind velocity around the wind alarm level.



static switch-on delay



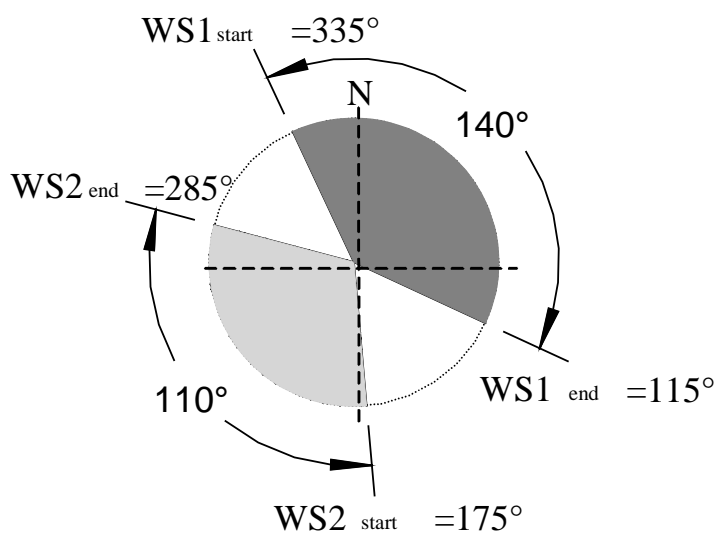
dynamic switch-on delay

4.6 Wind sector

A wind alarm with the selection of wind alarm type 3 or 4 can only be triggered if the wind direction occurs in a specific sector. Outside this wind sector the prevailing wind velocity is not relevant (see **section 4.2**).

The input of a wind sector (WS) is always in a clockwise direction, beginning with the starting point (WS_{start}) of the sector. This is followed by input of the sector end point (WS_{end}) rotating in a clockwise direction.

A maximum of two wind sectors can be input (see figure for an example). When using two wind sectors, they may also overlap. For information about selection see **section 7.4**.



Example of 2 wind sectors

4.7 Functions of status LEDs

It is possible to identify the status of the wind alarm at any time and also from a great distance with the help of the status LEDs. These LEDs light up red and green. The status functions are as follows:

LED	Status function
Green	Device OK. No wind alarm
Red	Device OK. Wind alarm active
Flashes red	Error has occurred

Table 2: LED function

4.8 Relay functions

The relay outputs of the wind alarm unit are "low active".

If there is no wind alarm or error, the relays are picked up.

In the event of a wind alarm, an error message or power failure affecting the wind alarm unit, the relay drops out.

4.8.1 Definition:

Status of wind alarm unit		LED status	Relay-status [contact*]	
The wind data are outside the selected wind alarm criteria.	wind alarm = not active	GREEN	B+C= open	C+M = closed
The wind data are within the selected wind alarm range.	wind alarm = active	RED	B+C= closed	C+M = open
Error message (triggered by wind sensor)	wind alarm = active	"flashes" RED	B+C= closed	C+M = open
Power supply interrupted or absent	wind alarm = active	OFF	B+C= closed	C+M = open

* R = break contact, C = changeover contact, M = make contact

4.9 Error detection for wind sensor

During operation the wind sensors connected automatically undergo continuous monitoring. This includes checking the specific power consumption of the sensors and outputting an error message (see **section 9**) with any deviations.

4.9.1 Timeout function

However, as it is not possible to test all possible hardware faults, a timeout function is available here. This timeout function generates an error message if the wind velocity was = 0 (or wind direction < 3°) during a selectable time period. This function can be enabled or disabled via the display menu "WG Timeout Error" (see **section 7.8**). This timeout function is generally ineffective for serial data telegrams and in this case a telegram has to be received correctly at least every 10 seconds for no error to be reported.

4.10 Parameter key

The parameter key prevents unauthorised resetting of the selectable parameters. After switch-on of the wind alarm unit or a RESET the parameters are protected from being accidentally changed via the buttons / interface.

Additionally, the language of the menu navigation in the display can be changed-over between German and English.

4.11 RS485 serial interface

The serial COM interface can be used for the following functions as required:

- a. control and programming of the wind alarm unit in bus mode (see also **section 8**)
- b. connection of a wind transmitter (with automatic telegram output e.g. 4.382x.xx.xxx (see also **section 5.4**)

The baud rate for the interface can be set using the device menu (see **section 7.7**) or via the COM interface itself (see **section 8.3**). Any change in the baud rate via the COM interface will only take effect after the unit has been restarted. This can be carried out either with the RESET command ("RE0") or via a power reset.

After a reset the following text is automatically transmitted:

Language Setting German:

Windwarngeräet Vxx.x<CR>

Language Setting English:

Wind Alarm Unit Vxx.x<CR>

(**xx.x** = version number)

The input can process the following interface specification: 8N1, 7E1, 7O1.

Transmission takes place with the specification 8N1. The unit uses a response delay of 20 to 40ms to allow the remote station to switch over from transmit to receive in this time.

5 Connectable wind transmitters

The connectable wind transmitters fall into the following groups.

The wind transmitter code (= W code) in the tables is the ID number of the individual wind transmitter types and is required for programming via the COM interface (command "GT1", see **section 8.3**).

Note: For a summary list of connected wind transducer, see also Appendix 1.

5.1 Wind transmitter type group 1: Wind velocity transmitter Digital / Analogue

WV Digital	
Wind transmitter code	WV-Classic
00100	4.3303.22.007
00101	4.3303.22.000
	WV-FirstClass
00102	4.3351.x0.000
	Reed contact
00103	4.3515.5x.xxx
	WV-Compact
00104	4.3518.x0.xxx
00105	4.3519.x0.xx0
00106	4.3520.x0.xx0
00107	4.3619.x0.xx0
WV Analogue	
Wind transmitter code	WV-Compact
00200	4.3519.xx.141 0...50m/s
00201	4.3519.xx.741 0...50m/s
00202	4.3619.0x.141 0...60m/s
00203	4.3619.00.741 0...60m/s
00204	4.3619.01.741 0...75m/s
00205	4.3619.xx.441 0...40m/s

5.2 Wind transmitter type group 2: Combined wind transmitter Digital

Digital	
Wind transmitter code	Combined wind transmitter
00400	4.3336.22.000

5.3 Wind transmitter type group 3: Wind direction transmitter Digital / Analogue

WD-Digital	
Wind transmitter code	WD-Compact
00100	4.3129.60.xx0
	WD-FirstClass
00101	4.3150.x0.000 4.3151.x0.000
	WD-Classic

00102	4.3125.33.100
WD Analogue	
Wind transmitter code	WD-Compact
00200	4.3129.xx.x41

5.4 Wind transmitter type group 4: Wind transmitter with RS485 interface

Wind transmitters with an RS485 interface	
Wind transmitter code	US 2D
00500	4.3820.02.330
US 2D-Compact	
00500	4.3875.02.330

When connecting a wind transmitter with an RS485 interface (e.g. Ultrasonic Anemometer 2D 4.382x.xx.xxx or 4.3875.xx.xxx), the following conditions must be satisfied:

1. Power is supplied to the wind transmitter externally (not from the wind alarm unit).
2. The telegram received (e.g. US-Anemometer 2D "VD" or "VDT" telegram) must have the following format:

Position	Char.	Description	
1	STX	Hex 0x02	fixed positions
2	X	WV 1*10 ¹ digit *	
3	X	WV 1*10 ⁰ digit *	
4	.	Decimal point	
5	X	WV 1*10 ⁻¹ digit	
6		Space (0x20)	
7	X	WD 1*10 ² digit *	
8	X	WD 1*10 ¹ digit *	
9	X	WD 1*10 ⁰ digit	
10		Space (0x20)	variable
11	X	Sign	
12	X	°C 1*10 ¹	
13	X	°C 1*10 ⁰	
14	.	Decimal point	
15	X	°C 1*10 ⁻¹	
16		Space (0x20)	
17	X	Status	
18	X	Status	
19	*	Checksum identifier	
20	H	Checksum high	
21	H	Checksum low	
22	CR	Hex 0x0D	
23	ETX	Hex 0x03	

- Start character: "STX"
 - The positions for the parameters of wind velocity WV and wind direction WD are fixed.
 - Analysis of checksum in telegram (XOR between "STX" and "**")
 - End character: "CR"
 - Maximum length of telegram: 23 characters
 - *: or space allowed
-
- The telegram output from the wind transmitter must be automatic (not "on request"): output rate 0.5 to 5 seconds.
 - Baud rate 300 to 115200, 8 data bits, no parity (8N1) (alternatively 7E1, 7O1)

Example of programming a Sonic 2D 4.382x.xx.xxx:

- BR=5 (baud rate 9600 8N1)
- DM=0 or 1 or 2 (half duplex or full duplex)
- AV=0 (averaging corresponds to output rate OR)
- OR=1000 (output rate 1 second)
- TT=1 or 2 (automatic output VD or VDT telegram)

The device 4.3820.02.330 was designed to work together with the wind warning device.

5.4.1 List of wind transmitter types

A list of wind transmitters which can be connected depending on the wind alarm unit type selected can be output via the COM interface (command "GT0" and "RT0": see **section 8.3**).

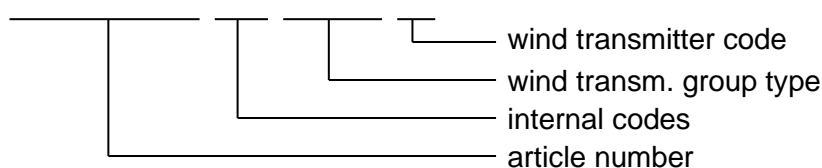
Wind alarm type 1 and 2
*4.3303.22.007, 0, 0 WV(dig) 100
*4.3303.22.000, 0, 0 WV(dig) 101
*4.3351.x0.000, 0, 2 WV(dig) 102
*4.3515.5x.xxx, 1, 5 WV(dig) 103
*4.3518.x0.xxx, 1, 3 WV(dig) 104
*4.3519.x0.xx0, 0, 4 WV(dig) 105
*4.3520.x0.xx0, 2, 3 WV(dig) 106
*4.3619.x0.xx0, 0, 7 WG(dig) 107
*4.3519.xx.141, 3,50 WV(ana) 200
*4.3519.x0.741, 3,50 WV(ana) 201
.....
Additionally with wind alarm type 3 and 4

*4.3336.22.000, 0, 0 Co(dig)	400
*4.3129.60.xx0, 0 WD(dig)	100
*4.3150.x0.000, 0 WD(dig)	101
4.3151.x0.000	
*4.3125.33.100, 0 WD(dig)	102
*4.3129.xx.x41, 3 WD(ana)	200

Table 3: List of wind transmitter types

Legend for Table 3:

*4.3303.22.007 , 0, 0 WV(dig) 100



5.5 Wind transmitter type group 5: connection of unlisted wind velocity transmitters (third-party transmitters)

Third-party wind velocity transmitter (digital)	
Wind transmitter code	Designation / Type
00300	e.g. WV third-party transmitter

If a digital wind velocity transmitter is not included in the device's internal selection list, there is the option of individual parameterisation of the WV input.

The following **parameters** must be entered via the input menu (see **section 7.13**):

1. M slope
2. B offset
3. f limit
4. lcc min
5. lcc max
6. Vcc

Parameters **1** and **2** define the characteristic of the wind velocity transmitter.

The wind velocity (V_{WG}) is calculated from the wind transmitter frequency (f_{Hz}) as follows:

$$V_{Ws} = M_{slope} * f_{Hz} + B_{offset}$$

As the factors M_{Fakt} & B_{Fakt} can only be input using whole numbers, these factors must be multiplied by 10000.

e.g. $M_{slope} = 0.0437 \rightarrow 0.0437 * 10000 = 437$

Parameter **3** "f limit" is input in Hz and specifies the maximum frequency of the wind velocity transmitter.

Parameters **4** and **5** specify the permissible power consumption range (minimum and maximum) of the wind velocity transmitter used. Input is in μA .

Note:

When measuring current, ensure accuracy acc. to the technical data (see section 12).

Parameter **6** "Vcc" specifies the supply voltage selected (V_{cc}) ($V_{cc_{max}} = 12V$). Input is in 1/10 Volt as shown below: e.g. **Vcc = 5V Input: 50**

Vcc = 4.2 V Input: 42

6 Installation

Caution

The device should only be installed and connected by a qualified technician who is familiar and complies with the general engineering regulations and applicable standards.

6.1 Recommendation for selection of site

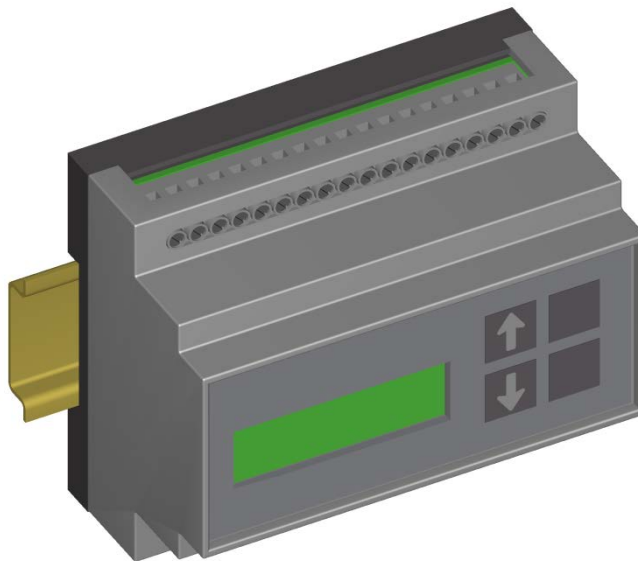
The device is designed for indoor installation. When used outdoors, an additional external housing with the appropriate type of protection is required.

Note

*When selecting the installation site, please take note of the operating temperature range and protection class (see **section 12**).*

6.2 Mechanical mounting

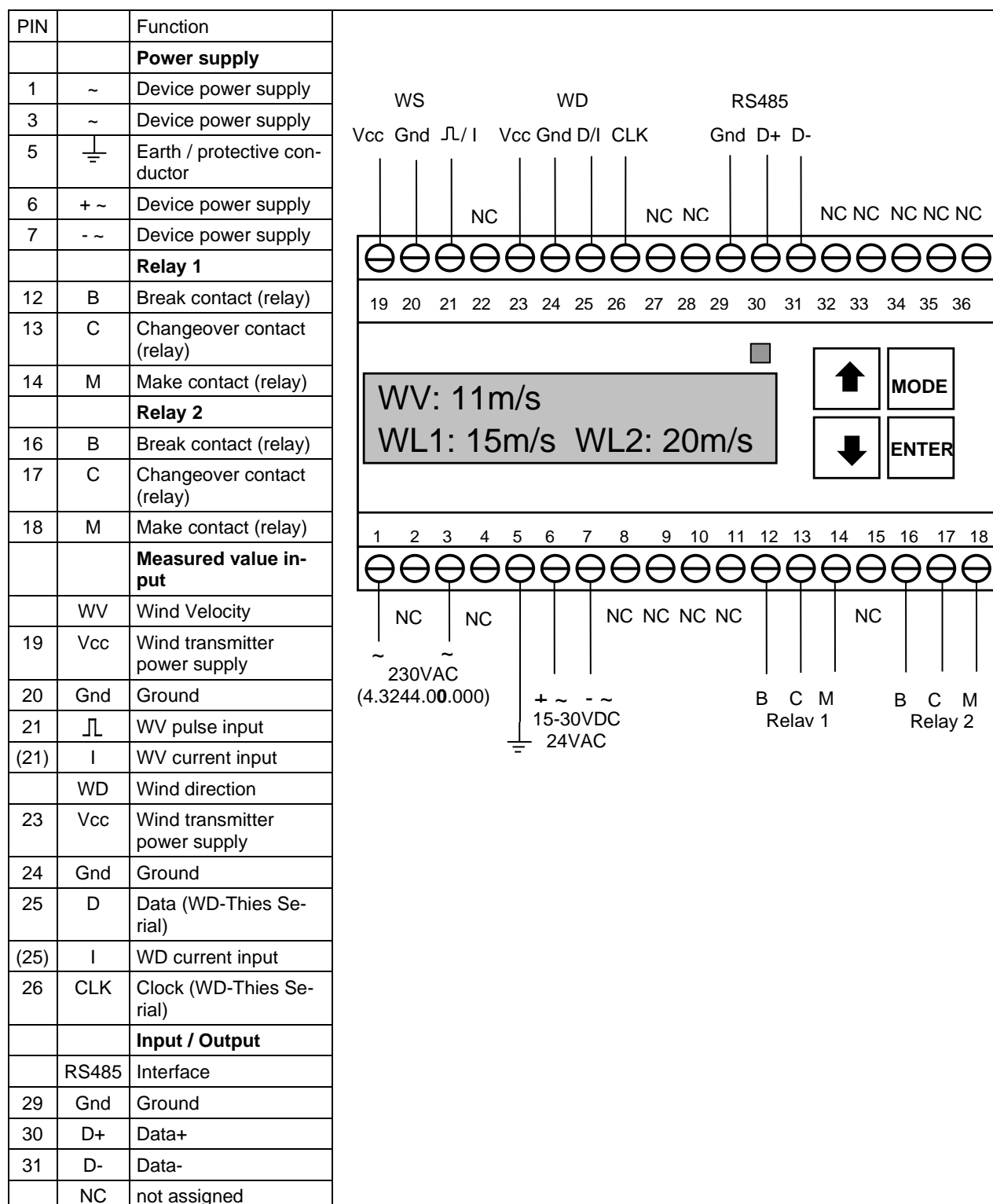
The wind alarm unit is designed for mounting on a 35mm carrier rail, which is not included in the scope of supply. The carrier rail must be positioned horizontally with the ventilation slots of the unit facing up and down. They must not be covered. A minimum distance of 10mm should be left on both sides.



6.3 Electrical installation

Connection

- power supply of wind alarm unit
- alarm channels (relay output)
- analog / digital wind transmitter and wind direction transmitter
- wind transmitter with RS485 or programming interface



Power supply:
 Power supply of 230V~ or 115V~ (terminal 1/3) can be used alternatively or simultaneously with 24V power supply (terminal 6/7).

Figure 9: Electrical connection

Connection of digital Combined wind transmitter (type: 4.3336.22.000)

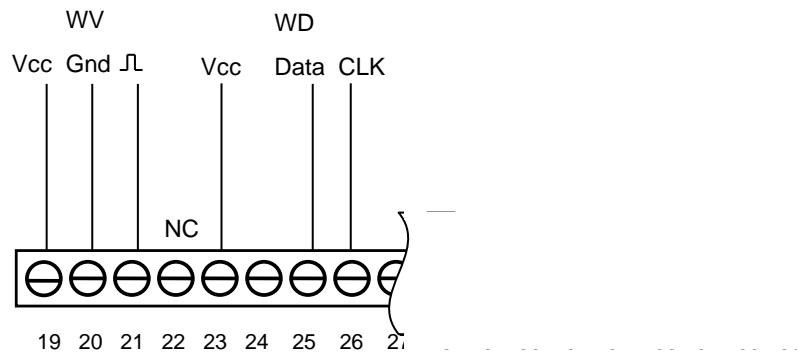


Figure 10: Connection of digital combi wind transmitter

Connection of digital wind transmitter with reed contact (e.g. 4.3515.5x.xxx)

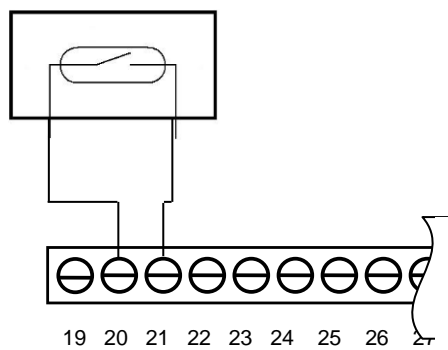


Figure 11: Connection of wind transmitter with reed contact

Connection relay output

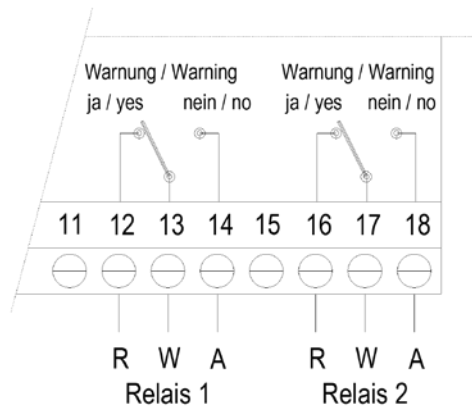


Figure 12: Relay output

RS485 input circuit

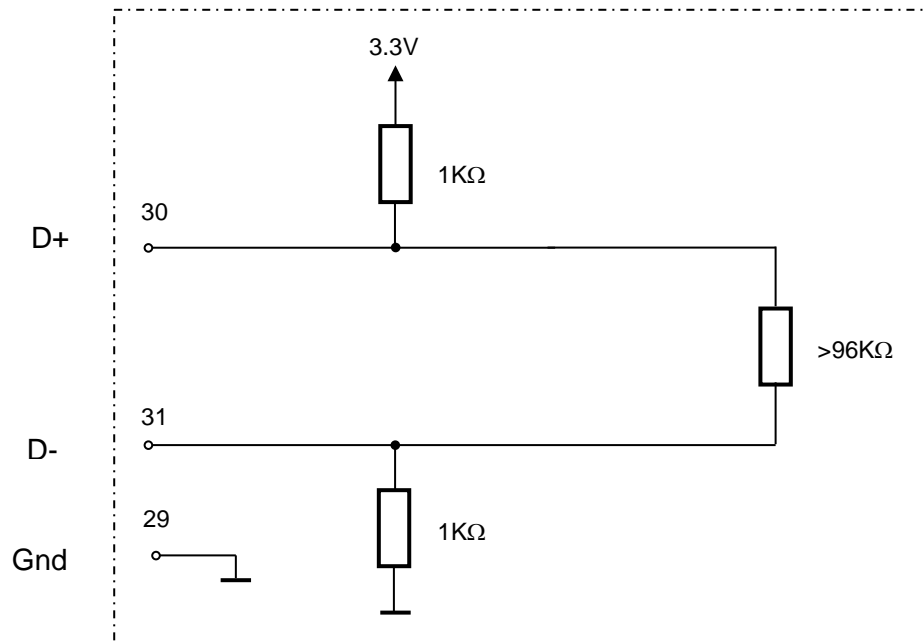
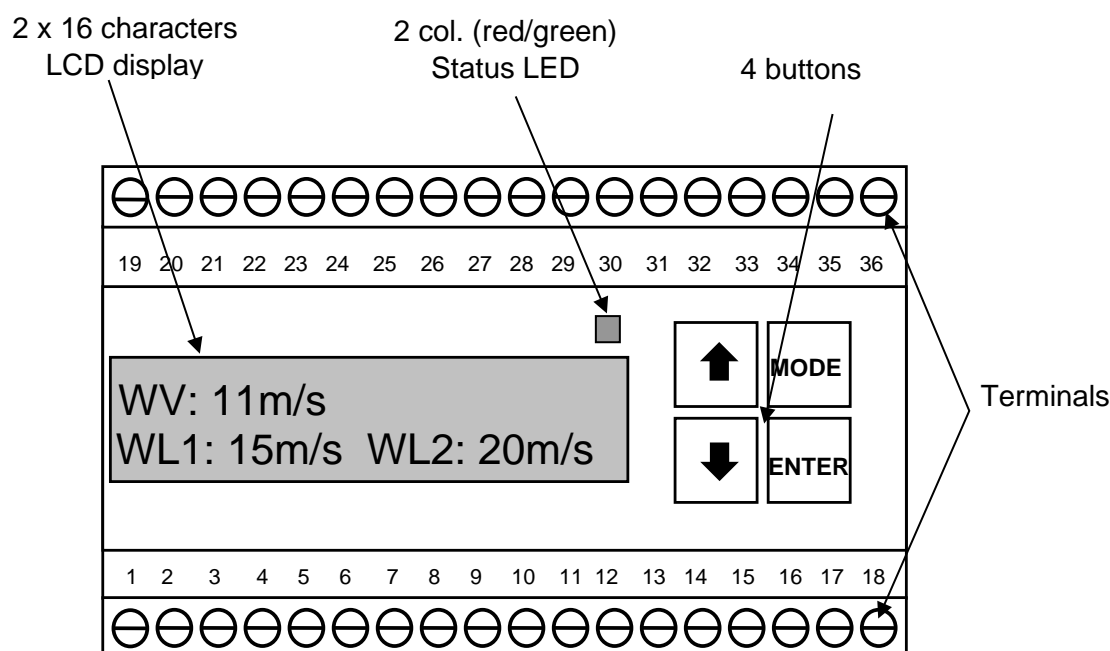


Figure 13: RS485 input circuit

7 Operation / Programming using buttons



Depending on the wind alarm type selected, four main menus with the following menu items are available for operation and programming of the wind alarm unit.

Wind alarm type 1		Wind alarm type 2		Wind alarm type 3		Wind alarm type 4	
1	Wind alarm status	1	Wind alarm status	1	Wind alarm status	1	Wind alarm status
2	Wind alarm level1	2	Wind alarm level1	2	Wind alarm level1	2	Wind alarm level1
3	Switch-on delay1	3	Switch-on delay1	3	Switch-on delay1	3	Switch-on delay1
4	Switch-off delay1	4	Switch-off delay1	4	Switch-off delay1	4	Switch-off delay1
5	WV hysteresis	5	Wind alarm level2	5	Wind sector1	5	Wind sector1
6	On delay stat/dyna	6	Switch-on delay2	6	WV hysteresis	6	Wind alarm level2
7	Off delay stat/dyna	7	Switch-off delay2	7	On delay stat/dyna	7	Switch-on delay2
8	Baud rate	8	WV hysteresis	8	Off delay stat/dyna	8	Switch-off delay2
9	WV timeout	9	On delay stat/dyna	9	Baud rate	9	Wind sector2
10	Wind alarm type	10	Off delay stat/dyna	10	WV timeout	10	WV hysteresis
11	WV group	11	Baud rate	11	Wind alarm type	11	On delay stat/dyna
12	WV type	12	WV timeout	12	WV group	12	Off delay stat/dyna
13	Parameter key	13	Wind alarm type	13	WV type	13	Baud rate
14	WA version No.	14	WV group	14	WD type	14	WV Timeout
15	Status U/I	15	WV type	15	Parameter key	15	Wind alarm type
		16	Parameter key	16	WA version No.	16	WV group

		17	WA version No.	17	Status U/I	17	WV type
		18	Status U/I			18	WD type
						19	Parameter key
						20	WA version No.
						21	Status U/I

Table 4: Display menu

Note:

stat/dyna = static/dynamic

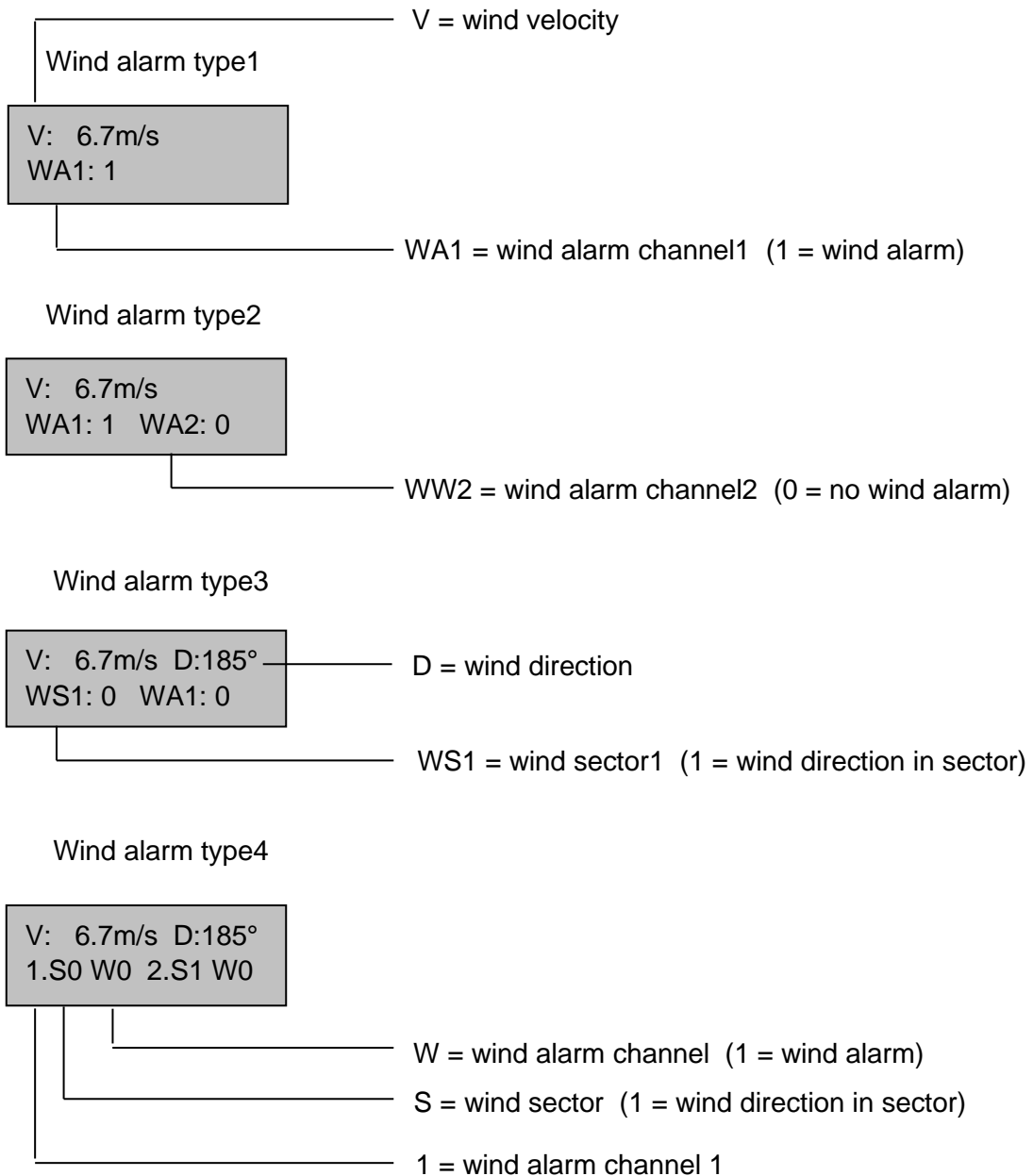
WD-type

Menu item not available if a Combined wind transmitter is configured.



Status indication (display):

When the wind alarm unit is switched on, the unit displays its status.

Depending on the wind alarm type selected the display will show the parameters wind velocity and wind direction as well as the wind alarm status.



Button functions:

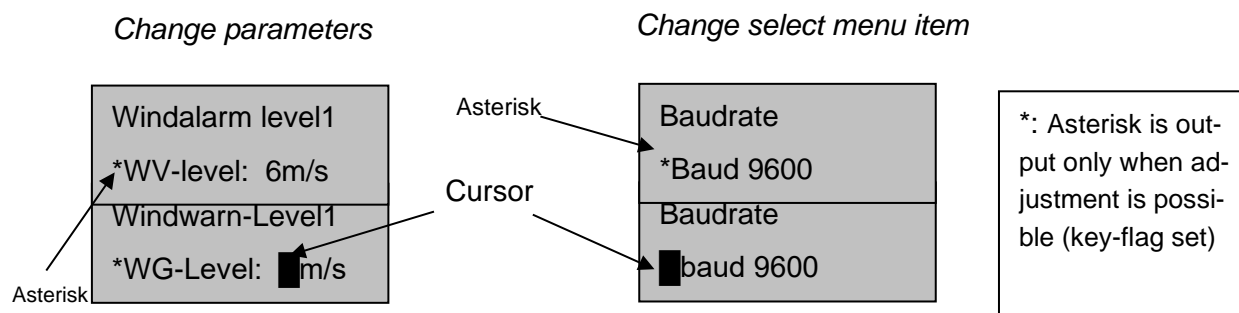
- The buttons  +  can be used to navigate to the individual menu items.
- The **MODE** button is used to select the menu item (parameter) and enable programming mode.
- If the **MODE** button is pressed again, you will either leave programming mode (parameters unchanged) or select the next parameter in the menu item.
- The **ENTER** button is used to save the selected parameters or the menu item and leave programming mode.
- If the **ENTER** button is pressed for more than 2 seconds, this will initiate a **reset** and the wind alarm unit restarts.





Special features:

If a line in the display is marked with an asterisk *, this indicates adjustable parameters or a selection menu in the line, when the parameter adjustment is activated (key-flag set)

A parameter selected with the **MODE** button is highlighted with a flashing cursor (see below: *Change parameters*).

A menu selected with the **MODE** button is highlighted with a flashing cursor at the asterisk * position (see below: *Change select menu item*).





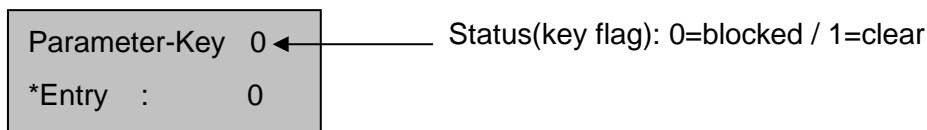
The buttons  +  are used to change the parameters. Every time the button is pressed, the parameter will be increased or reduced. If the buttons  +  are held down for more than 2sec, the parameter will automatically change, at an ever-increasing velocity.

Menu items are selected according to the same principle.

However, to make parameter settings (menu selections) you must clear the parameter setting (menu selection) beforehand by inputting a so-called key (see **section 7.1**). Whenever the device restarts, the parameter setting is blocked again. The clearance status is indicated by the key flag and the Asterisk (*') shown in the display. For programming examples see **section 7.14**.



7.1 Release of parameter setting (Parameter-Key)

Use the buttons  +  to scroll the "Parameter-Key" menu into the display:



Parameter-Key:



Press the **MODE** button, the parameter flashes.

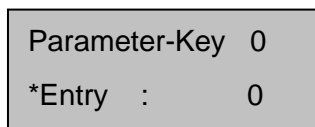
Use the buttons  +  to set the input value to **990**.

With the **ENTER** button clear the parameter setting or

press the **MODE** button to leave key mode without effecting release.

7.1.1 Language Settings

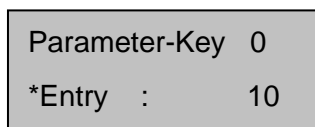
Use the buttons  +  to scroll the "Parameter-Key" menu into the display:



Parameter-Language:

Press the **MODE** button, the parameter flashes.

Use the buttons  +  to set the input value to **10**.



With the **ENTER** button change the language setting,

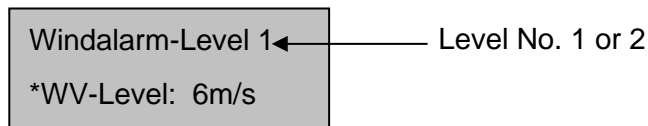
Remark:

- The switch-over of the language occurs only between German and English.
- With a reset of the wind alarm instrument the last-set language will remain.
- With the reset to factory-settings (DFO) the language is always set to German.

7.2 Selecting the Wind Velocity Level

For the meaning of the wind alarm level see **section 4.4**.

Use the buttons ▲ + ▼ to scroll the "WG-Level" menu into the display:



Press the **MODE** button, the parameter flashes.



Use the buttons ▲ + ▼ to set the parameter to the required value.

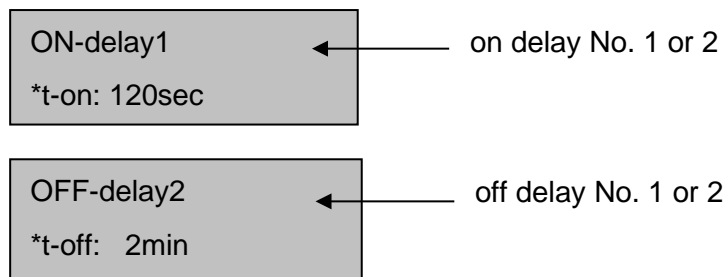
With the **ENTER** button save the parameter or

press the **MODE** button to leave programming mode without making any changes.



7.3 Selecting switch-on and switch-off delay

In terms of menu structure the switch-on and switch-off delay are identical. The only difference is that the parameter for the switch-on delay is input in **seconds** and for the switch-off delay in **minutes**. The delay function is explained in **section 4.5**.

Use the buttons  +  to scroll the "on delay" or "off delay" menu into the display:



Press the **MODE** button, the parameter flashes.



Use the buttons  +  to set the parameter to the required value.

With the **ENTER** button save the parameter or

press the **MODE** button to leave programming mode without making any changes.



7.4 Selecting wind sector

For further information about wind sectors in degrees see **section 4.6**.



Use the buttons  +  to scroll the "Wind sector" menu into the display:



Press the **MODE** button, parameter **S** (start of angle) flashes.

Use the buttons  +  to set the parameter to the required value.


Press the **MODE** button again, parameter **E** (end of angle) flashes.

Use the buttons  +  to set the parameter to the required value.

With the **ENTER** button save parameters **S** + **E** or press the **MODE** button to leave programming mode without making any changes.


7.5 Selecting Wind Velocity Hysteresis

The hysteresis function is explained in **section 4.4**.

Use the buttons  +  to scroll the WV hysteresis menu into the display:

WV hysteresis
*Hyst.: 1.0m/s

Press the **MODE** button, the parameter flashes.

Use the buttons  +  to set the parameter to the required value.



With the **ENTER** button save the parameter or

press the **MODE** button to leave programming mode without making any changes.

7.6 Selecting static or dynamic on/off delays



The function of the static or dynamic delays are explained in **section 4.5**.

In terms of menu structure the menus for static and dynamic processing of the switch-on and switch-off delay are identical.

Use the buttons  +  to scroll the on-delay / off-delay menu into the display:

Delay static/dyn *t-on static	Delay static/dyn *t-off static
*t-on dynamic	*t-off dynamic



Press the **MODE** button, the asterisk * flashes.

Use the buttons  +  to select the required menu item

With the **ENTER** button save the menu item or



press the **MODE** button to leave programming mode without making any changes.

7.7 Selecting baud rate

Use the buttons  +  to scroll the menu for selecting the baud rate of the serial interface into the display:

Baud rate	
*Baud	4800
*Baud	600
*Baud	1200
*Baud	2400
*Baud	4800
*Baud	9600
*Baud	19200
*Baud	38400
*Baud	57600
*Baud	115200

Press the **MODE** button, the asterisk * flashes.



Use the buttons  +  to select the required menu item.

With the **ENTER** button save the menu item or

press the **MODE** button to leave programming mode without making any changes.

7.8 Selecting WV timeout (Error)

The WV timeout time is specified in full hours (h). If 0h is input, timeout error detection is disabled. For further explanations about the function of the WV timeout see **section 4.9.1**.

Use the buttons  +  to scroll the WV timeout menu into the display:

WV-timeout error
*timeout: 3h



Press the **MODE** button, the parameter flashes.

Use the buttons  +  to set the parameter to the required value.

With the **ENTER** button save the parameter or



press the **MODE** button to leave programming mode without making any changes.

7.9 Selecting wind alarm type

Use the buttons  +  to scroll the menu for the wind alarm type (see **section 2.1**) into the display. As well as the wind alarm type the 1st line also gives the firmware version No.

WA-Version: V2.2	← version No.
*1. WV L1	
*2. WV L1 & L2	
*3. WV & WD L1	
*4. WV&WD L1&L2	



Press the **MODE** button, the asterisk * flashes.

Use the  +  buttons to select the required menu item

With the **ENTER** button save the menu item or press the **MODE** button to leave programming mode without making any changes.

7.10 Selecting wind transmitter type group

Selection of the wind alarm type (see **section 7.9**) is used to specify the select menu for the wind transmitter type group (see **section 5**). The select menu only contains the menu items, which are available from selecting the wind alarm type.

Use the buttons  +  to scroll the menu for the wind transmitter type group into the display:



Wind alarm type 1 or 2

Windsensor group
*WS digital
* WS analogue
*WS 3rd party

Wind alarm type 3 or 4

Windsensor group
*WS digital
*WS analogue
* WS 3rd party
*Combined dig.
*COM interface

Press the **MODE** button, the asterisk * flashes.



Use the buttons  +  to select the required menu item.

With the **ENTER** button save the menu item or
press the **MODE** button to leave programming mode without making any changes.

7.11 Selecting wind transmitter type



Selection of the wind transmitter type group (see **section 7.10**) will display the possible wind transmitter types in the Wind transmitter type menu. The wind transmitter currently selected is displayed here. A list of all possible wind transmitters is given in **section 5.4.1**.

e.g. selection of wind transmitter type from group "WV digital":

Use the buttons  +  to scroll the menu for the wind transmitter type into the display.

Wind sensor type *4.3303.22.000
*4.3303.22.007
*4.3520.x0.xx0
*4.3519.x0.xx0
*4.3518.x0.xxx
*4.3515.5x.xxx
*4.3351.x0.000

Press the **MODE** button, the asterisk * flashes.

Use the buttons  +  to select the required wind transmitter type.

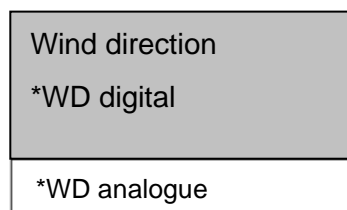
With the **ENTER** button activate the wind transmitter type or

press the **MODE** button to leave programming mode without making any changes.

7.12 Selecting wind direction transmitter type

This select menu is only available if no Combined wind transmitter is selected. You can choose between analog and digital wind direction transmitters irrespective of the wind transmitter selected (WG Digital/Analog).

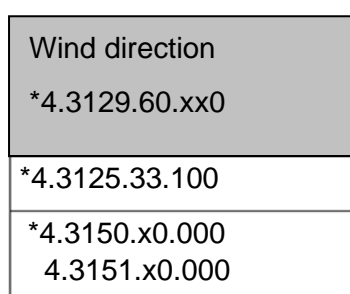
Use the buttons **↑** + **↓** to scroll the menu for the wind direction transmitter type into the display:



Press the **MODE** button, the asterisk * flashes.

Use the buttons **↑** + **↓** to select the required wind direction type.

With the **MODE** button switch to the menu for selection of the wind direction transmitter.





Use the buttons **↑** + **↓** to select the required wind direction transmitter.

With the **ENTER** button activate the wind direction transmitter input or

press the **MODE** button to leave programming mode without making any changes.

7.13 Parameterisation of a third-party wind transmitter



For information about the parameterisation of a digital wind velocity transmitter see **section 5.5**. The wind transmitter type group must be set to “WV third-party transmitter” (see **section 7.10**).

Use the buttons  +  to scroll the menu item "WV 3rd party" into the display:

WS 3rd party
*M slope 480
*B offset 1
*f limit 1000 Hz
*Icc min 1 uA
*Icc max 1000 uA
*Vcc 60V/10

Press the **MODE** button, the asterisk * flashes.

Press the **MODE** button again. The cursor flashes at the parameter.

Use the buttons  +  to select the parameter value

With the **ENTER** button save the wind transmitter type or

press the **MODE** button to leave programming mode without making any changes.

Note

Repeat this operation for every parameter. The selections can only be made using the buttons; parameters cannot be changed with a serial command.

7.14 Programming examples

Example 1: Change wind transmitter type

Selected wind transmitter: 4.3303.22.007 (digital)

New wind transmitter: 4.3519.x0.741 (analog)

1. Activate parameter key (key flag = 1, see **section 7.1**)
2. In the wind transmitter group menu select "**WG analog**" (see **section 7.10**) and press the **ENTER** button. The parameter key is deactivated (key flag = 0).
3. Activate parameter key again (key flag = 1)
4. In the wind transmitter group menu select "**4.3519.x0.741**" and press the **ENTER** button. The parameter key is deactivated (key flag = 0).

Example 2: Change wind alarm level 1 + 2

Selected wind alarm level: 1 = 8m/s, 2 = 13m/s

New wind alarm level: 1 = 10m/s, 2 = 15m/s

1. Activate parameter key (key flag = 1, see **section 7.1**)
2. In the wind alarm level 1 menu select 10m/s (see **section 7.2**) and press the **ENTER** button (new level active).
3. In the wind alarm level 2 menu select 15m/s and press the **ENTER** button (new level active).
4. Hold down the **ENTER** button for more than 2sec (reset).
The parameter key is deactivated (key flag = 0).

8 Operation / Programming via COM interface

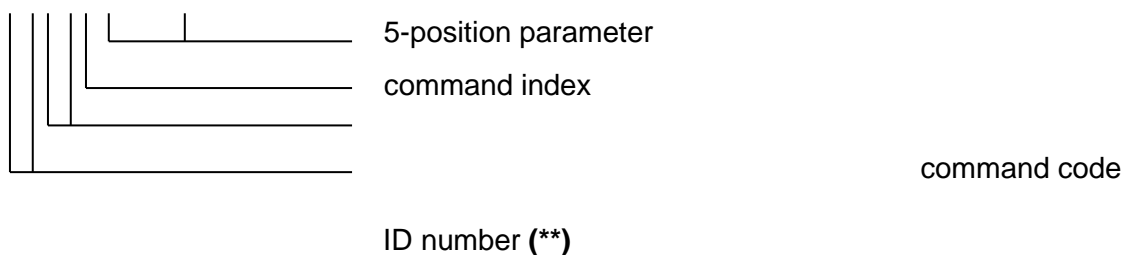
Most functions for operation and programming can also be set via the serial COM interface. In addition, various parameters can be queried for testing and control.

8.1 Format

The command set for communication with the wind alarm unit has the following structure:

Write command:

nnXXnYYYYY<CR>

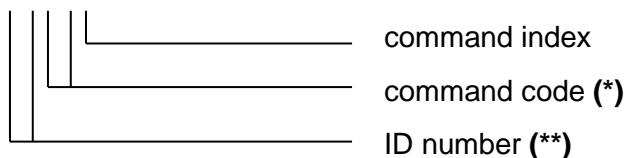


Note

There is no response from the unit after a write command.

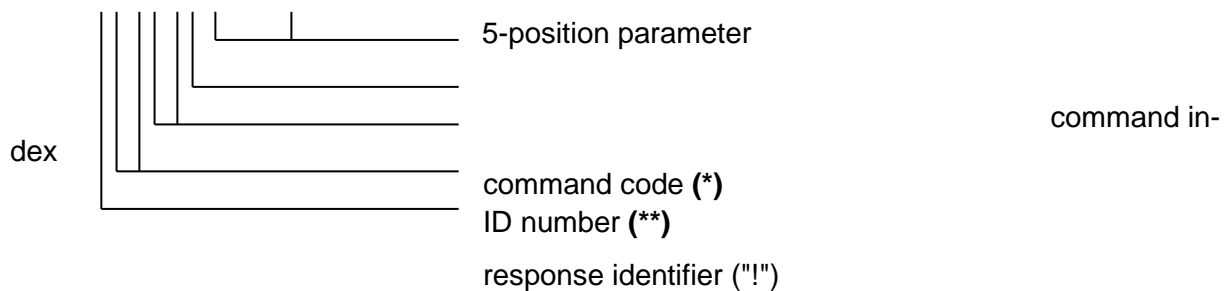
Read command:

nnXXn<CR>



Read command response telegram:

!nnXXnYYYYY<CR>



(*): Command code: for overview see **section 8.2** and **8.3**.

(**): ID number: for setting see command "ID". If the setting is unknown, "99" (so-called joker) can also be used.

8.2 List of commands

The following table contains an overview of all commands. For further information about individual commands see **section 8.3**.

No.	Command code	Parameter	Basic setting	Description
1	ST(0/1/2)	-	-	Device status
2	RE0	-	-	Reset (wind alarm unit) (*)
3	WT1	0 - 3	0	Wind alarm type (0: Type1 ... 3: Type4)
4	GT0 GT1	- 100 - 500	- 100	Output list of types WV wind transmitter type (see Table 3: List of wind transmitter types)
5	RT0 RT1	- 100 - 200	- 100	Output list of types WD wind transmitter type (see Table 3: List of wind transmitter types)
6	GL(1/2) GL3	0 - 50 [m/s] 0 - 30 [1/10 m/s]	2 / 8 10	WV level 1/2 WV hysteresis
7	EZ(1/2) EZ3	0 - 120 [s] 1.2	5 / 6 1	On delay 1/2 On delay (stat/dyna) (1:static, 2:dynamic)
8	AZ(1/2) AZ3	0 - 240 [min] 0.1	1 / 1 1	Off delay 1/2 Off delay (stat/dyna) (1:static, 2:dynamic)
9	RS(1/2) RS(3/4)	0 - 360[°]	10 / 90 180 / 270	Wind direction sector 1 (start/end) Wind direction sector 2 (start/end)
10	BD1	0 - 9	5 (9600Bd)	Baud rate (300 ... 115200) (see Table 6: Baud rate code)
11	TO1	0 - 24 [h]	6	WV timeout (0h: off)
12	WG0	-	-	WV actual value [1/10 m/s]
13	WR0	-	-	WD actual value [°]
14	VG0	-	-	Vcc voltage - WV (digital/analog) [1/10 V]
15	VR0	-	-	Vcc voltage - WD (digital/analog) [1/10 V]
16	IG0	-	-	Icc current - wind velocity [µA]
17	IR0	-	-	Icc current - wind direction [µA]
18	TI0	-	-	Indoor temperature [°C]
19	ID1	0 - 98	0	ID number (99: joker)
20	DF0	-	-	Basic parameter setting
21	KY0 KY(1/2)	- nnnnn / -	0 0 / -	Parameter key state (0:blocked, 1:clear) (**) Set parameter key / query
22	ER0	-	-	Error code (0 ... 99) (see Table 7: Error message)
23	AD(0-3)	-	-	AD converter values

Table 5: List of commands

(*): Reset with this command or a power reset is necessary for changes to take effect.

(**): Parameters cannot be changed if key is not released ("990").

8.3 Commands

The individual commands are explained in greater detail below. See **Table 5: List of commands** for valid minimum and maximum values.

Please note

"xx" in the examples stands for the ID number (see also **section 8.1** and command 19 "ID1"). If the ID number is unknown, "99" can also be used as a joker.

Parameters cannot be changed if key is not released (see also command 21 "KY0").

Changes to parameters will only take effect after a reset (e.g. command 2 "RE0").

1. ST0 - Device version No.

Query:	xxST0	Query version of firmware
Response: e.g.	!xxST000015	(version No. 15)
Query:	xxST1	Query wind alarm status channel 1
Response: e.g.	!xxST000001	(channel 1: 1 = alarm)
Query:	xxST2	Query wind alarm status channel 2
Response: e.g.	!xxST000000	(channel 2: 0 = no alarm)

2. RE0 – Reset of wind alarm unit

Note

Reset is necessary for changes to take effect.

Query:	xxRE0	Reset device
Response:	!xxRE000000	

3. WT1 – Wind alarm type

For details of the 4 possible wind alarm types see **section 2.1**.

Query:	xxWT1	Query wind alarm type selected
Response: e.g.	!xxWT100000	(wind alarm type 1)
Write: e.g.	xxWT100002	(wind alarm type 3)

4. GT(n) – WV wind transmitter type

The type of wind velocity wind transmitter can be programmed with command "GT1". The so-called W code , which can be queried with "GT0", should be used here.

Query:	xxGT0	
Response:	Output of list of wind transmitter types depending on wind alarm type selected (see section 5.4.1)	

Query:	xxGT1	Query W code for WV wind transmitter type
Response: e.g.	!xxGT100104	(W code = 00104 → 4.3518.x0.xxx)

Write: e.g.	xxGT100101	(W code = 00101 → 4.3303.22.000)
-------------	------------	----------------------------------

5. RT(n) – WD wind transmitter type

The type of wind direction wind transmitter can be programmed with command "RT1". The so-called W code , which can be queried with "RT0", should be used here

Query:	xxRT0	
Response:	Output of list of wind transmitter types depending on wind alarm type selected (see section 5.4.1)	

Query:	xxRT1	Query W code for WD wind transmitter type
Response: e.g.	!xxRT100200	(W code = 00200 → 4.3519.xx.141)

Write: e.g.	xxRT100102	(W code = 00102 → 4.3125.33.100)
-------------	------------	----------------------------------

6. GL(n) – Wind velocity level + WV hysteresis

For information about the function of the wind velocity level and WV hysteresis see **section 4.4**.

Query:	xxGL1	Query WV level1
Response: e.g.	!xxGL100004	(WV level1 = 4m/s)
Write: e.g.	xxGL100007	(WV level1 = 7m/s)
Query:	xxGL2	Query WV level2
Response: e.g.	!xxGL200006	(WV level2 = 5m/s)
Write: e.g.	xxGL200009	(WV level2 = 9m/s)
Query:	xxGL3	Query WV hysteresis
Response: e.g.	!xxGL100011	(WV hysteresis = 1.1m/s)
Write: e.g.	xxGL100005	(WV hysteresis = 0.5m/s)

7. EZ(n) – Switch-on delay + on delay (static/dynamic)

For information about the switch-on delay function see **section 4.5**.

Query:	xxEZ1	Query switch-on delay1
Response: e.g.	!xxEZ100100	(on-delay1 = 100 sec)
Write: e.g.	xxEZ100120	(on-delay1 = 120 sec)
Query:	xxEZ2	Query switch-on delay2
Response: e.g.	!xxEZ200120	(on-delay2 = 120 sec)
Write: e.g.	xxEZ200060	(on-delay2 = 60 sec)
Query:	xxEZ3	Query switch-on delay (stat./dyn.)
Response: e.g.	!xxEZ300001	(on-delay = static)
Write: e.g.	xxEZ300002	(on-delay = dynamic)

8. AZ(n) – Switch-off delay + off-delay (static/dynamic)

For information about the switch-off delay function see **section 4.5**.

Query:	xxAZ1	Query switch-off delay1
Response: e.g.	!xxAZ10002	(off-delay1 = 2 min)
Write: e.g.	xxAZ100005	(off-delay1 = 5 min)
Query:	xxAZ2	Query switch-off delay2
Response: e.g.	!xxAZ200004	(off-delay2 = 4 min)
Write: e.g.	xxAZ200010	(off-delay2 = 10 min)
Query:	xxAZ3	Query switch-off delay (stat./dyn.)
Response: e.g.	!xxAZ300001	(off-delay = static)
Write: e.g.	xxAZ300002	(off-delay = dynamic)

9. RS(n) – Wind direction sector

For information about the function of the wind direction sector see **section 4.6**.

Query:	xxRS1	Query WD sector start1
Response: e.g.	!xxRS100090	(WD sector start1 = 90 \angle°)
Write: e.g.	xxRS100100	(WD sector start1 = 100 \angle°)
Query:	xxRS2	Query WD sector end1
Response: e.g.	!xxRS200130	(WD sector end1 = 130 \angle°)
Write: e.g.	xxRS200190	(WD sector end1 = 190 \angle°)
Query:	xxRS3	Query WD sector start2
Response: e.g.	!xxRS300230	(WD sector start2 = 230 \angle°)
Write: e.g.	xxRS300260	(WD sector start2 = 260 \angle°)
Query:	xxRS4	Query WD sector end2
Response: e.g.	!xxRS400350	(WD sector end2 = 350 \angle°)

Write: e.g. xxRS400040 (WD sector end2 = 40 °)

10. BD(n) – Baud rate

Query: xxBD1 Query baud rate
 Response: e.g. !xxBD100005 (baud rate = 9600, see **Table 6**)

Write: e.g. xxBD100007 (baud rate = 38400)

No.	Baud
0	300
1	600
2	1200
3	2400
4	4800
5	9600
6	19200
7	38400
8	57600
9	115200

Table 6: Baud rate code

11. TO1 – Timeout wind velocity

For information about the timeout function, see **section 4.9.1**. If timeout is set to 0, timeout monitoring will not take place.

Query: xxTO1 Query of timeout setting
 Response: e.g. !xxTO100005 (WV timeout = 5h)

Write: e.g. xxTO100010 (WV timeout = 10h)

12. WG0 – Wind velocity - actual value

Query:	xxWG0	Query wind velocity
Response: e.g.	!xxWG000173	(WV actual value = 17.3m/s)

13. WR0 – Wind direction - actual value

Query:	xxWR0	Query wind direction
Response: e.g.	!xxWR000325	(WD actual value = 325 ↙)

14. VG0 – WV transmitter - Vcc (digital/analog)

Query:	xxVG0	Query selected supply voltage of wind velocity transmitter
Response: e.g.	!xxVG000050	(WV Vcc-actual value = 5.0V)

15. VR0 – WD transmitter - Vcc (digital/analog)

Query:	xxVR0	Query selected supply voltage of wind direction transmitter
Response: e.g.	!xxVR000050	(WD-Vcc-actual value = 5.0V)

16. IG0 – WV transmitter -Icc - actual value

Query:	xxIG0	Query measured supply current of wind velocity transmitter
Response: e.g.	!xxIG000825	(WV Icc- actual value = 825 uA)

17. IR0 – WD transmitter -Icc - actual value

Query:	xxIR0	Query measured supply current of wind direction transmitter
Response: e.g.	!xxIR001225	(WV Icc- actual value = 1225 uA)

18. TI0 – Wind alarm unit indoor temperature

Query:	xxTI0	Query indoor temperature
Response: e.g.	!xxTI000025	(indoor temperature = 25 °C)
	!xxTI065534	(indoor temperature = -2 °C, negative value: -65536)

19. ID1 – Device ID number

This number is required if more than one device with an identical command structure is used for the same serial bus. In this case the user must have its own ID number. Use of ID=0 is not recommended due to the standard factory setting of ID=0 on delivery.

Query:	xxID1	
	or	
Query:	99ID1	99: universal ID number (joker)
Write e.g.	xxID10012	(ID number = 12)
	or	
Write e.g.	99ID10012	(ID number = 12)

20. DF0 – Default parameters

This command is used to reset all parameters again and automatically restart the device.

The parameter values of the default state are shown in **Table 5: List of commands**.

Query:	xxDF0	Select default parameters
Response:	!xxDF000000	

21. KY(n) – Parameter key

The parameter key must generally have been released beforehand to change settings. Value "990" should be programmed here with the command "KY1".

Query: e.g.	xxKY0	Query state of parameter key
Response: e.g.	!xxKY000001	(key flag =1 -> clear) (0 -> blocked)

Write e.g.	xxKY100990	Parameter key = 990:	release
	xxKY100000	Parameter key <> 990:	blocked

Query:	xxKY2	Query valid parameter key
Response:	!xxKY200990	(parameter key = 990)

22. ER0 – Error code

For an overview of all error codes: see **Table 7: Error message**.

Query:	xxER0	
Response: e.g.	!xxER000012	(E12 WD(Vcc))

23. AD(n) – AD converter values

The values of 4 AD channels can be queried werden for diagnostic purposes.

Query:	xxAD0	
Response: e.g.	!xxAD001157	(n WV increments)

Query:	xxAD1	
Response: e.g.	!xxAD100239	(n WD increments)

Query:	xxAD2	
Response: e.g.	!xxAD200128	(n AGND(Offset) increments)

Query:	xxAD3	
Response: e.g.	!xxAD302048	(n Uref / 2 increments)

9 Error messages

If an error is detected during operation, an error message will be shown on the display for at least 3 seconds or as long as the error is present, in addition to the flashing red LED display. Both relays will also be switched off (see also **section 4.8**).

The error message only appears in line 2 of the status display.

e.g.

V: 6.7m/s E03 WG(lcc)

Error code	Error text	Comment/Action	Sensor digital	Sensor analog
E01	WV(Fuse)	WV(Vcc) fuse. Switches Vcc off when lcc(max) exceeded (*)	X	
E02	WV(Vcc)	WV(Vcc) outside tolerance	X	
E03	WV(lcc)	WV(lcc) outside tolerance	X	
E04	WV-Kabel	Cable (connection) defective	X	---
E05	WV(freq.)	f(wg) outside tolerance	X	---
E07	WV(no-Puls)	No input signal (frequency, timeout) (**)	X	---
E08	WV-Messb.	WV analog measuring range exceeded	---	X
E09	WV(A-Signal)	WV analog (timeout) no analog signal (**)	---	X
E11	WD(Fuse)	WD(Vcc) fuse. Switches Vcc off when lcc(max) exceeded (*)	X	
E12	WD(Vcc)	WD(Vcc) outside tolerance	X	
E13	WD(lcc)	WD(lcc) outside tolerance	X	
E15	WD-Seriell	WD serial transmission error	X	---
E18	WD-Messb.	WD analog measuring range exceeded	---	X
E19	WD(A-Signal)	WD analog (timeout) no analog signal (**)	---	X
E20	ADC	Analog-Digital-Converter error (***)	---	---
E30	Timeout	COM timeout (no telegram received for 10 sec)	X	---
E31	COM	COM error (incorrect telegram or wrong baud rate)	X	---
E99	Watchdog	Watchdog error (***)	---	---

Table 7: Error messages

- (*): When the error message appears, the relevant Vcc channel can be switched on again with a power reset or reset with the ENTER button (press for 2 seconds, see also **section 7**).
- (**): Timeout selectable, see also **section 4.9.1** and **7.8**.
- (***): Internal self-diagnosis on start-up.

10 Maintenance

The wind alarm unit does not require maintenance.

Cleaning:

To clean the housing a slightly dampened cloth should be used without chemical cleaning agents.

Storage:

The wind alarm unit must be stored in a dry room free of dust at a temperature between -20.. + 50°C. We recommend storing the device in a cardboard box.

Fuse:

A PTC (automatically resettable) fuse is used on the secondary side.

11 Example: Installation / Setting / Start-up

Problem:

Introduction of protective measures for a building by

- monitoring the east facade in wind sector 0...180° at > 5 m/s
- monitoring the west facade in wind sector 180..360° at > 10 m/s

Devices:

- 1 x wind velocity transmitter e.g. 4.3519.00.141
- 1 x wind direction transmitter e.g. 4.3129.00.141
- 1 x Universal wind alarm unit 4.3244.00.000

Installation and setting - procedure:

A) Pre-installation of devices				
Step	Doc./section	Measure		Comment
1	OI	Select site for wind velocity transmitter and wind direction transmitter		For installation of wind transmitters please see relevant operating instructions (OI) of device.
2	OI	Perform mechanical mounting of wind velocity transmitter and wind direction transmitter		
3	6.1	Select site for wind alarm unit		
4	6.2	Perform mechanical mounting of wind alarm unit		
5	6.3	Connect wind alarm unit to mains power supply		
B) Setting / operation / programming of wind alarm unit using buttons				
Step	Doc./section	Measure	Setting/Display	Comment
1	7.1	Set parameter key	990	
2	7.9	Select wind alarm type (mode)	4.WG+WR L1+L2	A reset automatically takes place after input and the parameter flag (key) is cleared. Reset then required (Step 1).
3	7.10	Select wind transmitter type group	WV digital	
4	7.11	Select wind transmitter type	4.3519.00.141	
5	7.12	Select wind direction transmitter type	4.3129.00.141	
6	7.2	Select wind alarm level 1	5 m/s	
7	7.3	Select switch-on delay 1	60 sec	
8	7.3	Select switch-off delay 1	2 min	
9	7.4	Select wind sector 1	0...180	
10	7.2	Select wind alarm level 2	10 m/s	
11	7.3	Select switch-on delay 1	30 sec	
12	7.3	Select switch-off delay 1	1 min	
13	7.4	Select wind sector 2	180...360	

14	7.5	Select WV hysteresis	1.0 m/s	
15	7.6	Select static / dynamic switch-on delay	t-on static	
16	7.6	Select static / dynamic switch-off delay	t-off dynamic	
17	7.7	Select baud rate	9600	
18	7.8	Select timeout	1 h	
19	7.1	Block unit (press ENTER >2 sec)		
C) Final installation of devices				
Step	Doc./section	Measure	Setting/Display	Comment
1	6.3	Electrical connection of wind velocity transmitter and wind direction transmitter to wind alarm unit		
2		Check no errors have occurred: no error message should appear.	Line1: Measured values must appear Line2: Wind alarm status must be visible.	
3	6.3	Assign relay outputs of wind alarm unit according to data sheet		

Setting / operation / programming of wind alarm unit via COM interface

- For procedure see section 8

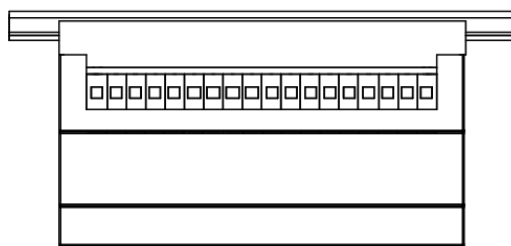
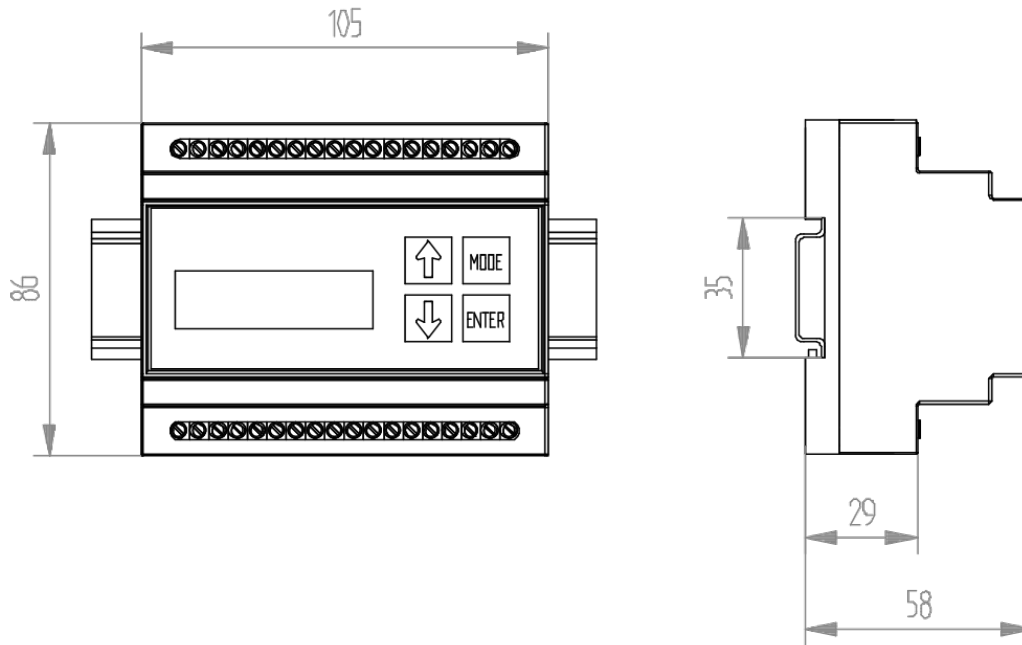
12 Technical data

Display		
	Type	LCD yellow/green backlit
	Display	2 x 16 characters
Status LED	2 LED colours	green → no alarm red → 1 or 2 alarms red flashing → error message
Wind velocity		
Input (digital)	Input	Frequency, max. 1600Hz
	Level (U _A)	U _A (low) ≤1V , U _A (high) ≥3.3V
	Sampling rate	1Hz
Input (analog)	Input	4 ... 20mA
	Measuring range	depending on wind transmitter type selected
	Burden	220Ω (input 0/4 ... 20mA)
	Input resistance	34kΩ (input 5V); 23kΩ (input 10V)
	Accuracy	±0.2% of meas. range
Wind transmitter power supply	Vcc	5V ... 13V
Digital	Icc(max)	43mA (electronic fuse)
Analog	Icc(max)	48mA (electronic fuse)
Wind direction		
Input (digital)	Input	Thies-Serial
	Type	5bit, 8bit
	Clock	Period =1ms
Input (analog)	Input	4 ... 20mA
	Measuring range	0 ... 360 degrees
	Burden	220Ω (input 0/4 ... 20mA)
	Input resistance	34kΩ (input 5V); 23kΩ (input 10V)
	Accuracy	±0.3% of meas. range
Wind transmitter power supply	Vcc	5 ... 13V
Digital	Icc(max)	43mA (electronic fuse)
Analog	Icc(max)	48mA (electronic fuse)
Wind alarm parameters		
Wind alarm range	WV level	1 ... 50m/s
	Resolution	1m/s

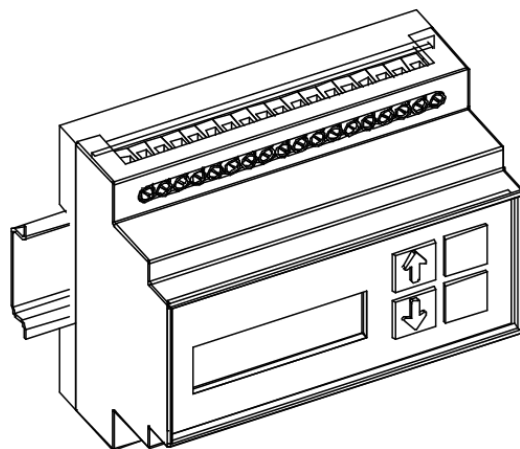
	WV hysteresis	0 ... 3m/s
	WV hyst. resolution	0.1m/s
Switch-on delay	t (on) delay	0 ... 120sec
	t (on) resolution	1sec
Switch-off delay	t (off) delay	0 ... 240min
	t (off) resolution	1min
Wind alarm processing	static / dynamic	See section 4.4
Timeout	Time	0 ... 24h (WD or WV = zero)
	Resolution	1 h
Alarm outputs		
Relay 1 + 2		Changeover contact (low active = relay dropped)
	Load AC	Max. 5A 250VAC cos=1
	Load DC	0.01 5A 5 ... 30VDC
Serial interface		
	Type	RS485 half-duplex (full fail-safe receiver)
	Termination	See Figure 13: RS485
	Response delay	20 ... 40ms
Data format	Output format	8N1
	Input format	7E1, 8N1, 7O1
	Baud rate	300, 600, 1200, 2400, 4800, 9600, 19200, 38400, 57600, 115200
Sensor	Thies VD or VDT telegram	e.g. Thies Sonic 2D, 4.382x.xx.xxx or Thies Sonic 2D compact, 4.3875.xx.xxx
Parameter key		990 (release key for changing parameters) 10 (Language switching German/English)
General		
Operating voltage	Mains (*)	230VAC (type 4.3244.00.000)
	Low voltage (*)	24VAC $\pm 10\%$ or 15 ... 30VDC
	Power consumption	Max. 10VA
	Fuse	PTC (secondary)
	Temperature range	-20 ... +50 °C
	Humidity range	non-condensing
	Altitude	<1000m
Housing	Mounting on carrier rails	Standard rail as per DIN EN 60 715 TH35
	Protection	IP20

(*): Mains and low voltage can be used alternatively or simultaneously

13 Dimension drawing



Tragschiene TS 35 x 7,5 DIN EN 60715



14 More Information / Documents as download

Following documents are available for download via the link.

Instruction for use

https://www.thiesclima.com/db/dnl/4.3244.0x.000_Wind_Alarm_Unit_Universal_eng.pdf

15 EC-Declaration of Conformity

Manufacturer: Adolf Thies GmbH & Co. KG
 Hauptstraße 76
 37083 Göttingen, Germany
<http://www.thiesclima.com>

Product: Wind Alarm Instrument

Doc. Nr. 2006-44784_CE

Article Overview:

4.3244.00.000 4.3244.04.000 4.3244.50.000

The indicated products correspond to the essential requirement of the following European Directives and Regulations:

2014/30/EU	26.02.2014	DIRECTIVE 2014/30/EU OF THE EUROPEAN PARLIAMENT AND OF THE COUNCIL of 26 February 2014 on the harmonisation of the laws of the Member States relating to electromagnetic compatibility.
2017/2102/EU	15.11.2017	DIRECTIVE (EU) 2017/2102 of the European Parliament and of the Council of November 15, 2017 amending Directive 2011/65 / EU on the restriction of the use of certain hazardous substances in electrical and electronic equipment.
2012/19/EU	13.08.2012	DIRECTIVE 2012/19/EU OF THE EUROPEAN PARLIAMENT AND OF THE COUNCIL of 4 July 2012 on waste electrical and electronic equipment (WEEE).
2018/1139/EU	04.07.2018	Regulation (EU) 2018/1139 of the European Parliament and of the Council of 4 July 2018 on common rules in the field of civil aviation and establishing a European Union Aviation Safety Agency.

The indicated products comply with the regulations of the directives. This is proved by the compliance with the following standards:

DIN EN 61000-6-2	2019-11	Electromagnetic compatibility Immunity for industrial environment
DIN EN 61000-6-3:2007 + A1:2011	2011-09	Electromagnetic compatibility (EMC). Generic standards. Emission standard for residential, commercial and light-industrial environments
DIN EN 61010-1	2020-03	Safety requirements for electrical equipment for measurement, control, and laboratory use. General requirements
DIN EN 63000	2019-05	Technical documentation for the assessment of electrical and electronic products with respect to the restriction of hazardous substances.

Legally binding signature:



General Manager - Dr. Christoph Peper

Legally binding signature:



Development Manager - ppa. Jörg Peterleit

This declaration certifies the compliance with the mentioned directives, however does not include any warranty of characteristics.
 Please pay attention to the security advises of the provided instructions for use.

16 UK-CA-Declaration of Conformity

Manufacturer: Adolf Thies GmbH & Co. KG
 Hauptstraße 76
 37083 Göttingen, Germany
<http://www.thiesclima.com>

Product: Wind Alarm Instrument

Doc. Nr. 2006-44784_CA

Article Overview:

4.3244.00.000 4.3244.04.000 4.3244.50.000

The indicated products correspond to the essential requirement of the following Directives and Regulations:

1091	08.12.2016	The Electromagnetic Compatibility Regulations 2016
RoHS Regulations 2012	01.01.2021	The Restriction of the Use of Certain Hazardous Substances in Electrical and Electronic Equipment Regulations 2012
3113	01.01.2021	Regulations: waste electrical and electronic equipment (WEEE)
2018/1139/EU	04.07.2018	Regulation (EU) 2018/1139 of the European Parliament and of the Council of 4 July 2018 on common rules in the field of civil aviation and establishing a European Union Aviation Safety Agency.

The indicated products comply with the regulations of the directives. This is proved by the compliance with the following standards:

BS EN IEC 61000-6-2	25.02.2019	Electromagnetic compatibility (EMC). Generic standards. Immunity standard for industrial environments
BS EN IEC 61000-6-3	30.03.2021	Electromagnetic compatibility (EMC). Generic standards. Emission standard for equipment in residential environments
BS EN 61010-1+A1	31.03.2017	Safety requirements for electrical equipment for measurement, control, and laboratory use. General requirements
BS EN IEC 63000	10.12.2018	Technical documentation for the assessment of electrical and electronic products with respect to the restriction of hazardous substances

This declaration of conformity is issued under the sole responsibility of the manufacturer.

Legally binding signature:



General Manager - Dr. Christoph Peper

Legally binding signature:



Development Manager - ppa. Jörg Petereit

This declaration certifies the compliance with the mentioned directives, however does not include any warranty of characteristics.

Please pay attention to the security advises of the provided instructions for use.

Appendix 1: List of connected wind transmitter

Benennung / Type	Output Signal	Type / Article- No.
	WG-Digital	WG-Classic
Wind Velocity Transmitter, Type: Classic		4.3303.22.007
		4.3303.22.000
		WG-First Class
Wind Velocity Transmitter, Type: First Class		4.3351.x0.000
		Reedcontact
Wind Velocity Transmitter, Type: Small Wind Transmitter		4.3515.5x.xxx
		WG-Compact
Wind Velocity Transmitter, Type: Compact		4.3518.x0.xxx
		4.3519.x0.xx0
		4.3520.x0.xx0
	WG-Analogue	WG-Compact
Wind Velocity Transmitter, Type: Compact		4.3519.xx.141
		4.3519.xx.741
	WG / WR Digital	Comb. Wind Transmitter
Comb. Wind Transmitter, Type: Classic		4.3336.22.000
	WR-Digital	WR-Compact
Wind Direction Transmitter, Type: Compact		4.3129.60.xx0
		WR-First Class
Wind Direction Transmitter, Type: First Class		4.3150.x0.000
		4.3151.x0.000
		4.3125.33.100
	WR-Analogue	WR-Compact
Wind Direction Transmitter, Type: Compact		4.3129.xx.x41
	RS485	US 2D
Ultrasonic Anemometer US 2D		4.3820.02.330
		US 2D-Compact
Ultrasonic Anemometer US 2D Compact		4.3875.02.330

ekotechnika
měřicí technika pro ekologii

Ing. Milan Kříž - Ekotechnika

Kloboučnická 20, 140 00 Praha 4

☎ +420 241 414 111

✉ info@ekotechnika.com

🌐 www.ekotechnika.com

ADOLF THIES GMBH & CO. KG

Meteorology and environmental metrology

Hauptstraße 76 · 37083 Göttingen · Germany

Phone +49 551 79001-0 · Fax +49 551 79001-65

info@thiesclima.com

www.thiesclima.com

